

Data sheet | Item number: 285-635

2-conductor through terminal block; 35 mm²; with integrated end plate; side and center marking; only for DIN 35 x 15 rail; 2.3 mm thick; copper; CAGE CLAMP®

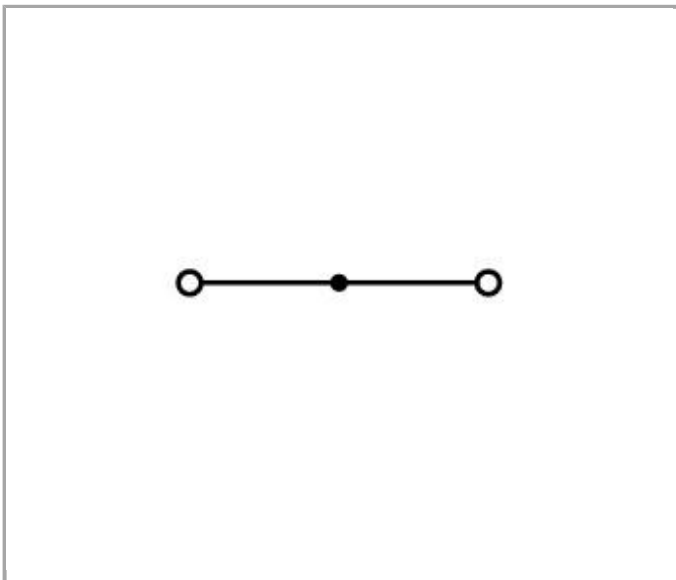

285-635

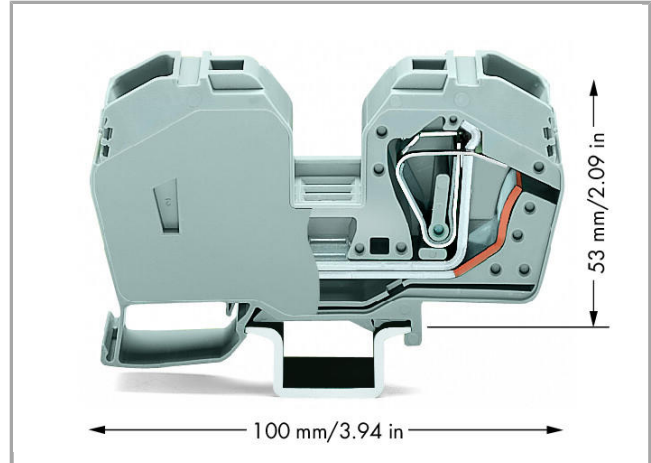
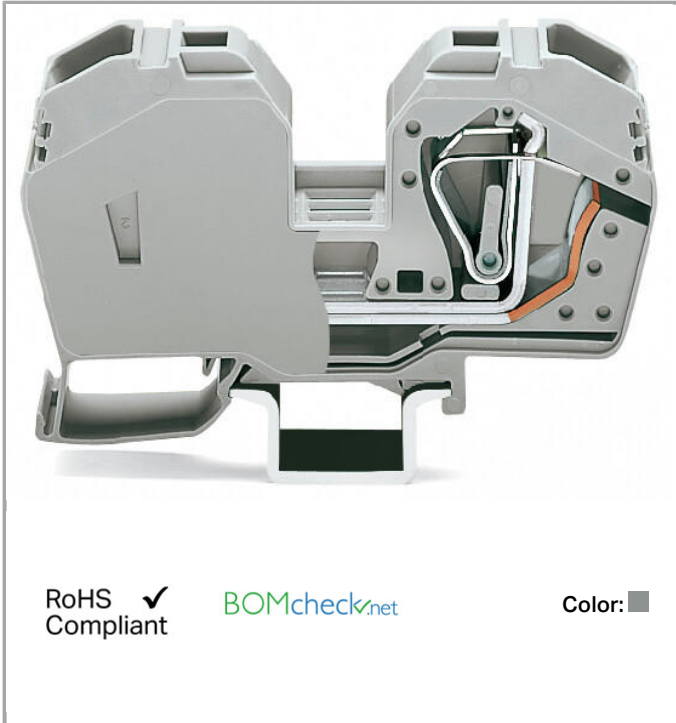

Item description

Safety information 1:

sively on DIN-35 x 15 rail

Data

Electrical data

Ratings per IEC/EN 60664-1

Rated voltage (III / 3)	1000 V
Rated impulse voltage (III / 3)	8 kV
Rated current	125 A

Connection data

Connection technology	CAGE CLAMP®
Actuation type	Operating tool
Connectable conductor materials	Copper
Nominal cross section	35 mm ²
Solid conductor	6 ... 35 mm ² / 8 ... 2 AWG
Fine-stranded conductor	6 ... 35 mm ² / 8 ... 2 AWG
Strip length	23 mm / 0.91 inch
Total number of connection points	2
Total number of potentials	1
Number of levels	1
Type of wiring	Front-entry wiring

Geometrical Data

Width	16 mm / 0.63 inch
Height from upper-edge of DIN-35 rail	53 mm / 2.087 inch
Depth	100 mm / 3.937 inch

Mechanical data

Design	horizontal
Type of mounting	DIN-35 rail
Marking level	Center/side marking

Material Data

Color	gray
Insulating material	Polyamide 66 (PA 66)
Fire load	1.078 MJ
Weight	87.349 g





Commercial data

Product Group	1 (Rail Mounted Terminal Blocks)
---------------	----------------------------------



Country of origin	PL
GTIN	4045454218713
Customs Tariff No.	85369010000

Approvals / Certificates

Country specific Approvals

Logo	Approval	Additional Approval Text	Certificate name
	CCA DEKRA Certification B.V.	EN 60947	NTR NL-7707
	CSA DEKRA Certification B.V.	C22.2	1151144
	CSA DEKRA Certification B.V.	C22.2 No. 158	1151144
	KEMA/KEUR DEKRA Certification B.V.	EN 60947	71-101911

Ship Approvals

Logo	Approval	Additional Approval Text	Certificate name
	ABS American Bureau of Shipping	EN 60947	14-HG1293677-PDA
	BV Bureau Veritas S.A.	EN 60947	07436/E0 BV
	LR Lloyds Register	EN 60947	91/20112 (E9)

UL-Approvals

Logo	Approval	Additional Approval Text	Certificate name
	UL Underwriters Laboratories Inc.	UL 1059	E45172



Compatible products

tools



Item no.: 210-721
Operating tool with partially insulated shaft; Type 3, blade (5.5 x 0.8) mm

210-721

Jumper



Item no.: 283-414
Step-down jumper; insulated; from 16 mm² to 4 mm²; Nominal current 32 A

283-414



Item no.: 285-435
Adjacent jumper; insulated; Nominal current 85 A

285-435

Protective Warning Marker



Item no.: 285-416
Protective warning marker; with high-voltage symbol, black; for 5 terminal blocks

285-416

potential distribution



Item no.: 283-407
Power tap; with 500 mm cable; for 16 mm² (283/783 Series) and 35 mm²

283-407

protection



Item no.: 285-401
Finger guard; touchproof cover protects unused conductor entries; for 35 mm² high-current tbs

285-401

Marking accessories



Item no.: 2009-115
WMB-Inline; for Smart Printer; on reel; stretchable 5 - 5.2 mm; plain; snap-on type

2009-115



Item no.: 2009-115/000-002
WMB-Inline; for Smart Printer; on reel; stretchable 5 - 5.2 mm; plain; snap-on type

2009-115



















Item no.: 2009-115/000-006
WMB-Inline; for smartPRINTER; on reel; stretchable 5 - 5.2 mm; plain; snap-on type















2009-115



















Item no.: 2009-115/000-007
WMB-Inline; for Smart Printer; on reel; stretchable 5 - 5.2 mm; plain; snap-on type



2009-115

	Item no.: 2009-115/000-012 WMB-Inline; for smartPRINTER; on reel; stretchable 5 - 5.2 mm; plain; snap-on type	/000-012	2009-115
	Item no.: 2009-115/000-017 WMB-Inline; for Smart Printer; on reel; stretchable 5 - 5.2 mm; plain; snap-on type	/000-017	2009-115
	Item no.: 2009-115/000-023 WMB-Inline; for Smart Printer; on reel; stretchable 5 - 5.2 mm; plain; snap-on type	/000-023	2009-115
	Item no.: 2009-115/000-024 WMB-Inline; for smartPRINTER; on reel; stretchable 5 - 5.2 mm; plain; snap-on type	/000-024	2009-115
	Item no.: 2009-145 Mini-WSB Inline; for Smart Printer; on reel; stretchable 5 - 5.2 mm; plain; snap-on type		2009-145
	Item no.: 2009-145/000-002 Mini-WSB Inline; for Smart Printer; on reel; stretchable 5 - 5.2 mm; plain; snap-on type	/000-002	2009-145
	Item no.: 2009-145/000-005 Mini-WSB Inline; for Smart Printer; on reel; stretchable 5 - 5.2 mm; plain; snap-on type	/000-005	2009-145
	Item no.: 2009-145/000-006 Mini-WSB Inline; for Smart Printer; on reel; stretchable 5 - 5.2 mm; plain; snap-on type	/000-006	2009-145
	Item no.: 2009-145/000-007 Mini-WSB Inline; for Smart Printer; on reel; stretchable 5 - 5.2 mm; plain; snap-on type	/000-007	2009-145
	Item no.: 2009-145/000-012 Mini-WSB Inline; for Smart Printer; on reel; stretchable 5 - 5.2 mm; plain; snap-on type	/000-012	2009-145
	Item no.: 2009-145/000-023 Mini-WSB Inline; for smartPRINTER; on reel; stretchable 5 - 5.2 mm; plain; snap-on type	/000-023	2009-145
	Item no.: 2009-145/000-024 Mini-WSB Inline; for Smart Printer; on reel; stretchable 5 - 5.2 mm; plain; snap-on type	/000-024	2009-145
	Item no.: 2009-198 Adaptor		2009-198
	Item no.: 209-185 Adaptor		209-185
	Item no.: 248-501 Miniature WSB Quick marking system; plain; Marker width 5 mm; 10 strips with 10 markers per card		248-501
	Item no.: 248-501/000-002 Mini-WSB marking card; as card; not stretchable; plain; snap-on type	/000-002	248-501

	Item no.: 248-501/000-005 Mini-WSB marking card; as card; not stretchable; plain; snap-on type	248-501 /000-005
	Item no.: 248-501/000-006 Mini-WSB marking card; as card; not stretchable; plain; snap-on type	248-501 /000-006
	Item no.: 248-501/000-007 Mini-WSB marking card; as card; not stretchable; plain; snap-on type	248-501 /000-007
	Item no.: 248-501/000-012 Mini-WSB marking card; as card; not stretchable; plain; snap-on type	248-501 /000-012
	Item no.: 248-501/000-017 Mini-WSB marking card; as card; not stretchable; plain; snap-on type	248-501 /000-017
	Item no.: 248-501/000-023 Mini-WSB marking card; as card; not stretchable; plain; snap-on type	248-501 /000-023
	Item no.: 248-501/000-024 Mini-WSB marking card; as card; not stretchable; plain; snap-on type	248-501 /000-024
	Item no.: 793-501 WMB marking card; as card; not stretchable; plain; snap-on type	793-501
	Item no.: 793-501/000-002 WMB marking card; as card; not stretchable; plain; snap-on type	793-501 /000-002
	Item no.: 793-501/000-005 WMB marking card; as card; not stretchable; plain; snap-on type	793-501 /000-005
	Item no.: 793-501/000-006 WMB marking card; as card; not stretchable; plain; snap-on type	793-501 /000-006
	Item no.: 793-501/000-007 WMB marking card; as card; not stretchable; plain; snap-on type	793-501 /000-007
	Item no.: 793-501/000-012 WMB marking card; as card; not stretchable; plain; snap-on type	793-501 /000-012
	Item no.: 793-501/000-017 WMB marking card; as card; not stretchable; plain; snap-on type	793-501 /000-017
	Item no.: 793-501/000-023 WMB marking card; as card; not stretchable; plain; snap-on type	793-501 /000-023

	Item no.: 793-501/000-024 WMB marking card; as card; not stretchable; plain; snap-on type	/000-024	793-501
	Item no.: 793-5501 WMB marking card; as card; for terminal block width 5 - 17.5 mm; stretchable 5 - 5.2 mm; plain; snap-on type		793-5501
	Item no.: 793-5501/000-002 WMB marking card; as card; for terminal block width 5 - 17.5 mm; stretchable 5 - 5.2 mm; plain; snap-on type	/000-002	793-5501
	Item no.: 793-5501/000-005 WMB marking card; as card; stretchable 5 - 5.2 mm; plain; snap-on type	/000-005	793-5501
	Item no.: 793-5501/000-006 WMB marking card; as card; stretchable 5 - 5.2 mm; plain; snap-on type	/000-006	793-5501
	Item no.: 793-5501/000-007 WMB marking card; as card; stretchable 5 - 5.2 mm; plain; snap-on type	/000-007	793-5501
	Item no.: 793-5501/000-012 WMB marking card; as card; stretchable 5 - 5.2 mm; plain; snap-on type	/000-012	793-5501
	Item no.: 793-5501/000-017 WMB marking card; as card; stretchable 5 - 5.2 mm; plain; snap-on type	/000-017	793-5501
	Item no.: 793-5501/000-023 WMB marking card; as card; stretchable 5 - 5.2 mm; plain; snap-on type	/000-023	793-5501
	Item no.: 793-5501/000-024 WMB marking card; as card; stretchable 5 - 5.2 mm; plain; snap-on type	/000-024	793-5501
Carrier rail			
	Item no.: 210-114 Steel carrier rail; 35 x 15 mm; 1.5 mm thick; 2 m long; unslotted; similar to EN 60715		210-114
	Item no.: 210-118 Steel carrier rail; 35 x 15 mm; 2.3 mm thick; 2 m long; unslotted; according to EN 60715		210-118
	Item no.: 210-197 Steel carrier rail; 35 x 15 mm; 1.5 mm thick; 2 m long; slotted; similar to EN 60715		210-197
	Item no.: 210-198 Copper carrier rail; 35 x 15 mm; 2.3 mm thick; 2 m long; unslotted; according to EN 60715		210-198
	Item no.: 210-506 Steel carrier rail; 35 x 15 mm; 1.5 mm thick; 2 m long; unslotted; galvanized; similar to EN 60715		210-506
	Item no.: 210-508 Steel carrier rail; 35 x 15 mm; 1.5 mm thick; 2 m long; slotted; galvanized; similar to EN 60715		210-508

ferrule

	<p>Item no.: 216-413 Ferrule; Sleeve for 25 mm² / AWG 4; uninsulated; electro-tin plated; electrolytic copper; gastight crimped; acc. to DIN 46228, Part 1/08.92</p>	216-413
	<p>Item no.: 216-414 Ferrule; Sleeve for 35 mm² / AWG 2; uninsulated; electro-tin plated; electrolytic copper; gastight crimped; acc. to DIN 46228, Part 1/08.92</p>	216-414

Downloads

Documentation

Bid Text

285-635	doc 24.1 kB	Download
---------	----------------	----------

CAD/CAE - Smart Data

CAD data

3D Download 285-635	URL	Download
---------------------	-----	----------

Subject to changes.